

The world's true measure of color

**HunterLab**



# THE BASICS OF COLOR PERCEPTION AND MEASUREMENT

# The Basics Of Color Perception and Measurement



This is a tutorial about color perception and measurement. It is a self teaching tool that you can read at your own pace.

When a slide has all information displayed, the following symbols will appear on the lower left side of the screen



To go back one slide click.



To advance one slide click.



To exit the presentation press the Escape key on your keyboard.





# Contents

There are five sections to this presentation:

[Color Perception](#)

[Color Measurement](#)

[Color Scales](#)

[Surface Characteristics and Geometry](#)

[Sample Preparation and Presentation](#)

If you wish to jump to a specific section click above on the appropriate name or click below to advance to the next slide.







# COLOR PERCEPTION



# Things Required To See Color



A Light Source

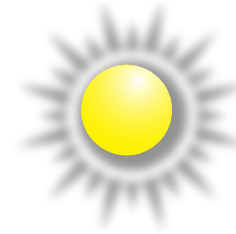

An Object

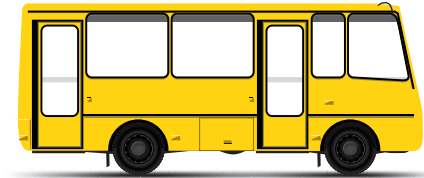

An Observer



# Visual Observing Situation



LIGHT SOURCE

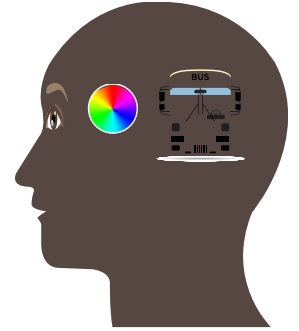
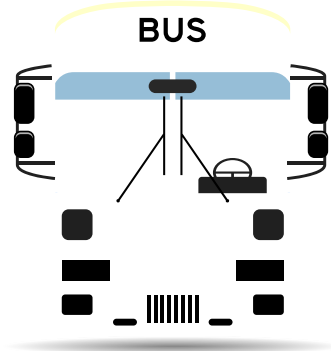

OBSERVER





# Visual Observing Situation



The visual observing model shows the three items necessary to perceive color.



To build an instrument that can quantify human color perception, each item in the visual observing situation must be represented as a table of numbers.

# Light Source



## Light Source



A light source emits white light.



When light is dispersed by a prism, all visible wavelengths can be seen.

# Sunlight Spectrum

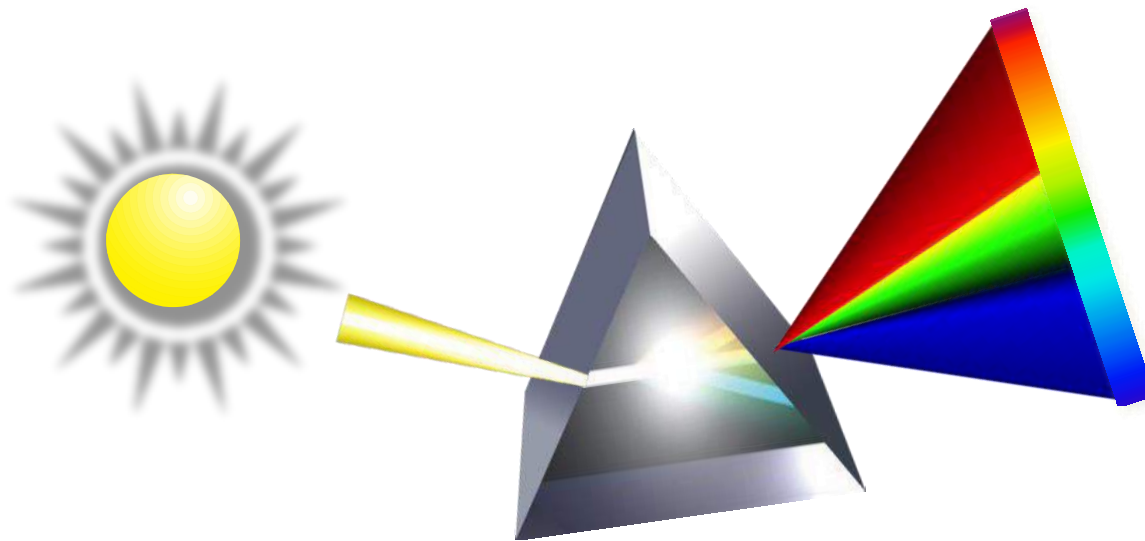
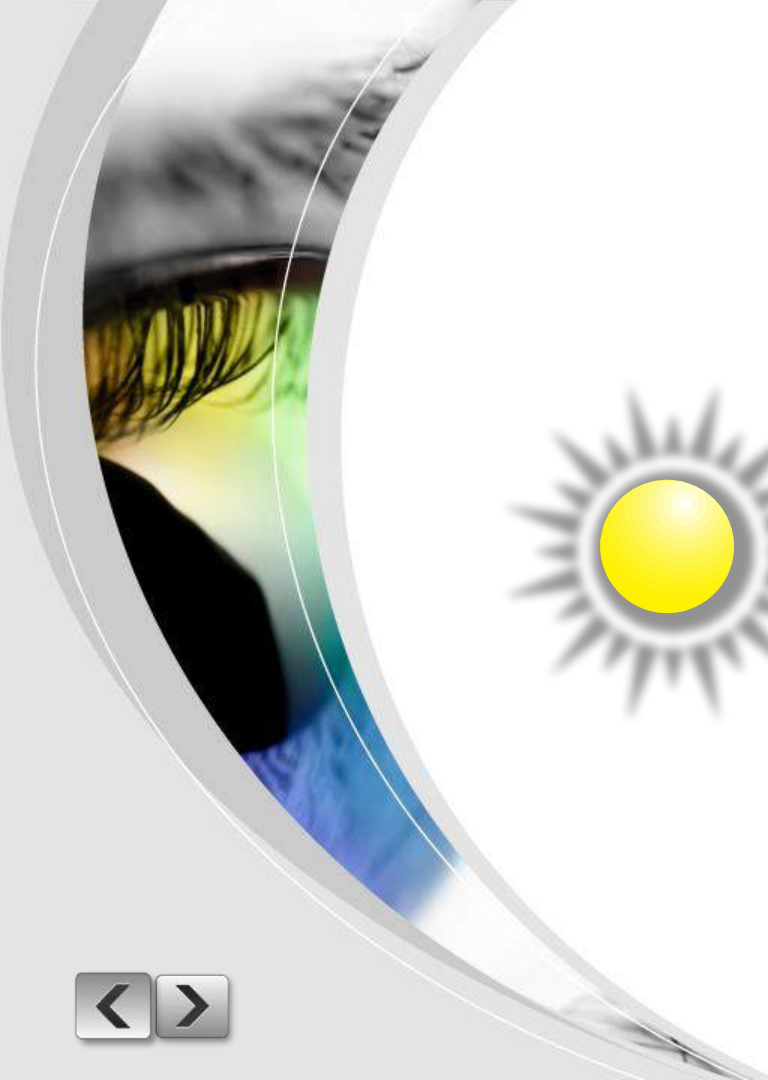

## Light Source



Visible light is a small part of the electromagnetic spectrum.



The wavelength of light is measured in nanometers (nm).



The CIE wavelength range of the visible spectrum is from 360 to 780 nm.



A plot of the relative energy of light at each wavelength creates a spectral power distribution curve quantifying the characteristics of the light source.

# Spectral Power Distribution of Sunlight



ULTRAVIOLET

VISIBLE SPECTRUM

INFRARED

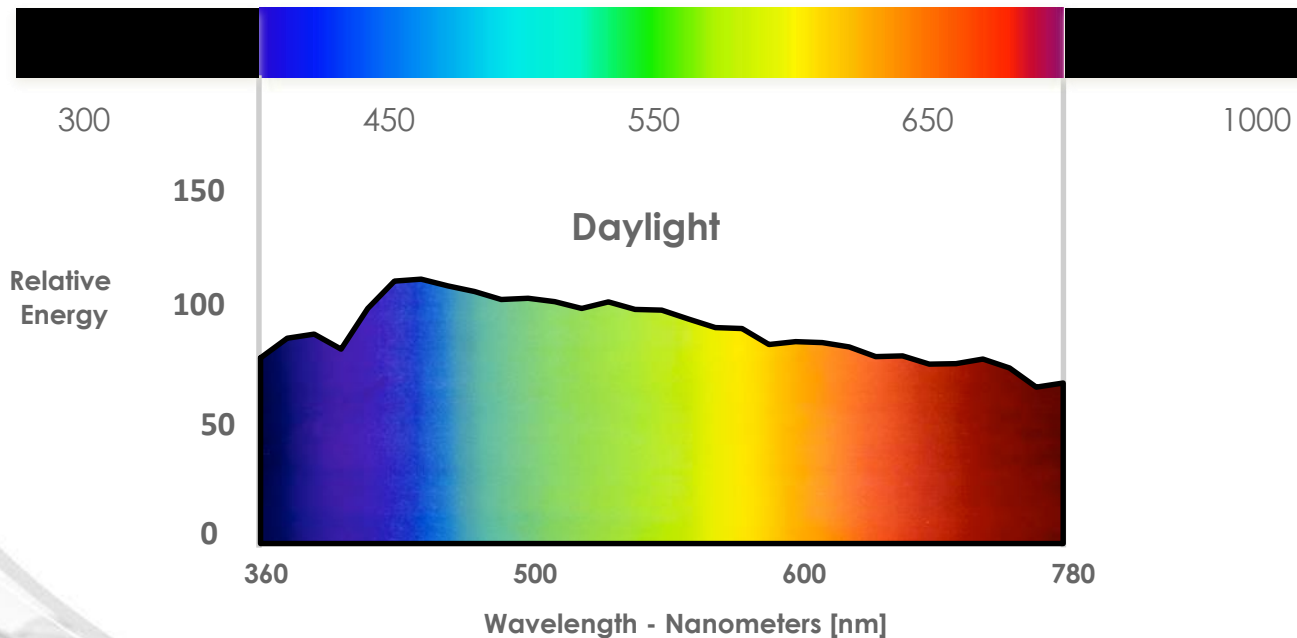



# Light Source versus Illuminant



A **light source** is a physical source of light.



A **CIE illuminant** is a standard table of numbers representing relative energy versus wavelength for the spectral characteristics of light sources.



# Light Source versus Illuminant



Source

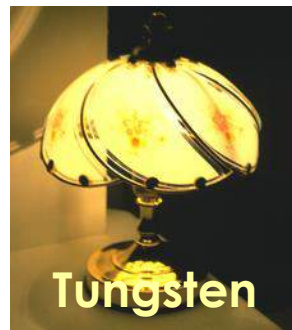

Illuminant

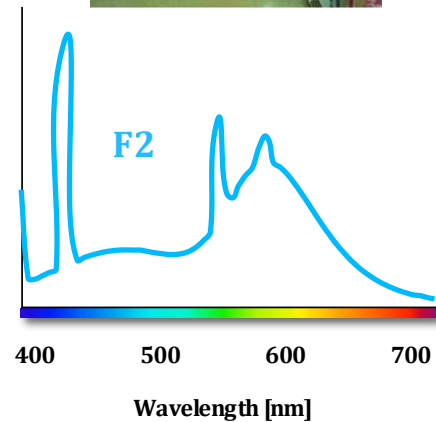
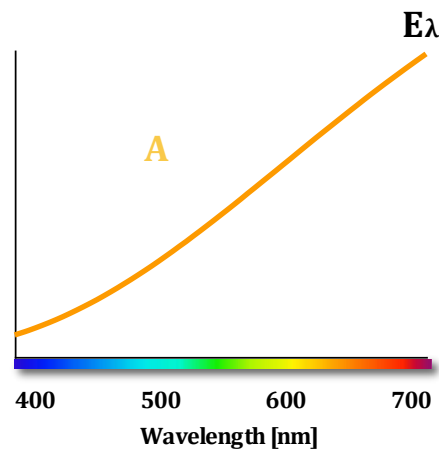
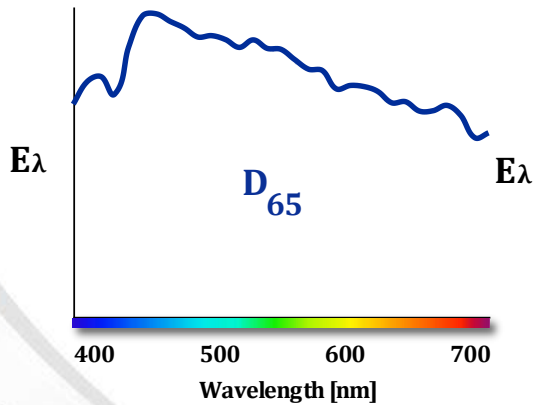

# Some Common Illuminants



- A** Incandescent
- C** Average Daylight
- D<sub>65</sub>** Noon Daylight
- F2** Cool White Fluorescent



## CIE Illuminant



By representing a light source as an illuminant, the spectral characteristics of the first element of the Visual Observing Situation have been **quantified** and **standardized**.

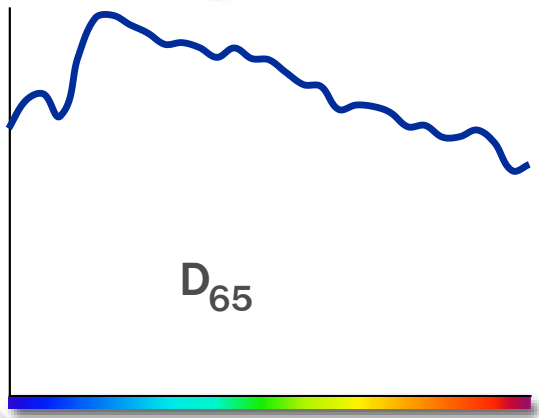
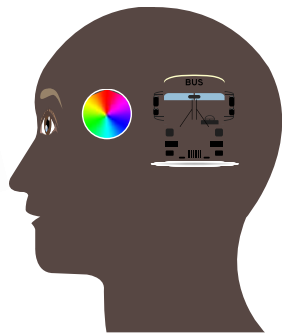
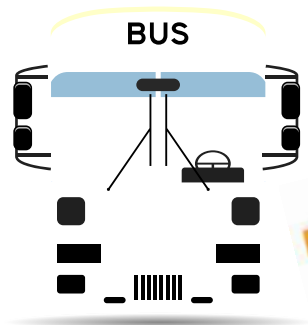

# Object

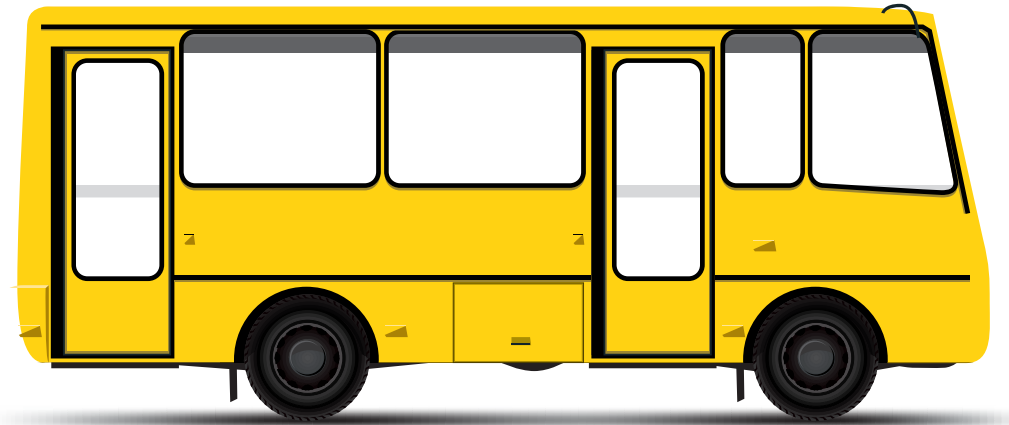



# Object



Objects modify light.

Colorants such as pigments or dyes, in the object, selectively absorb some wavelengths of the incident light while reflecting or transmitting others.

# Light Interaction with School Bus Paint



Incident Light

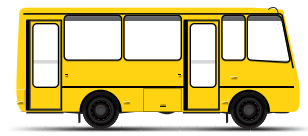

Specular Reflection

Diffuse Reflection

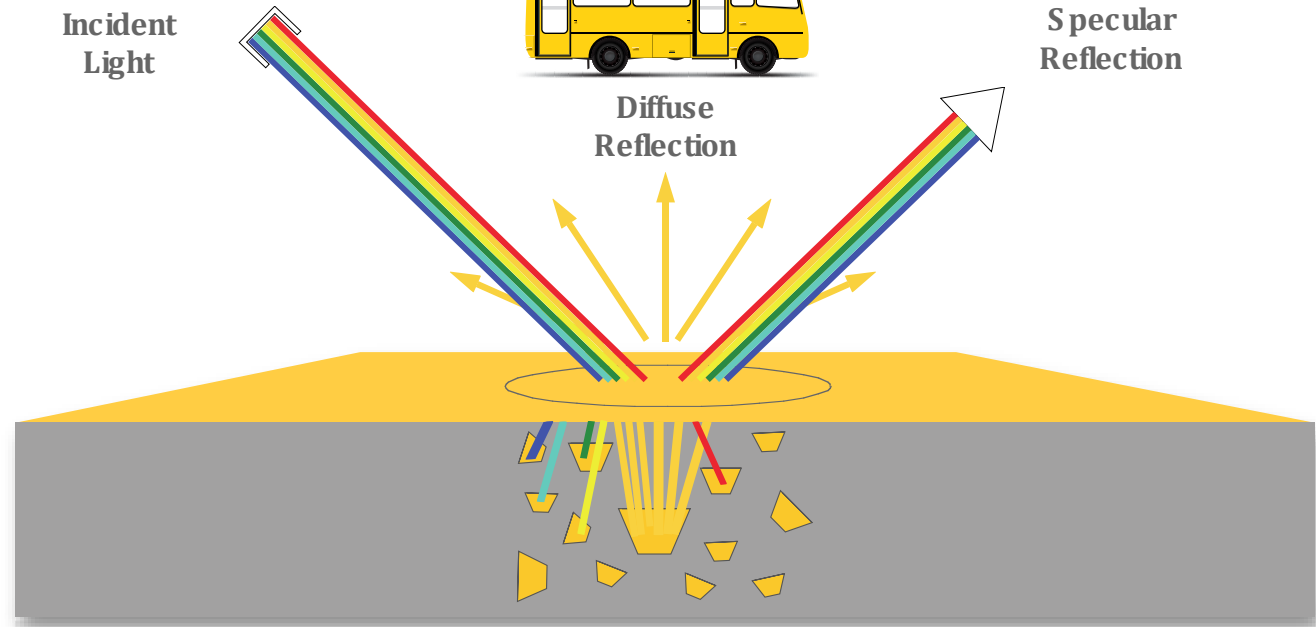

# Object



 The amount of light, reflected or transmitted by the object at each wavelength can be quantified.

This can be represented as a spectral curve.



# Spectrophotometric Curve for "School Bus Yellow"

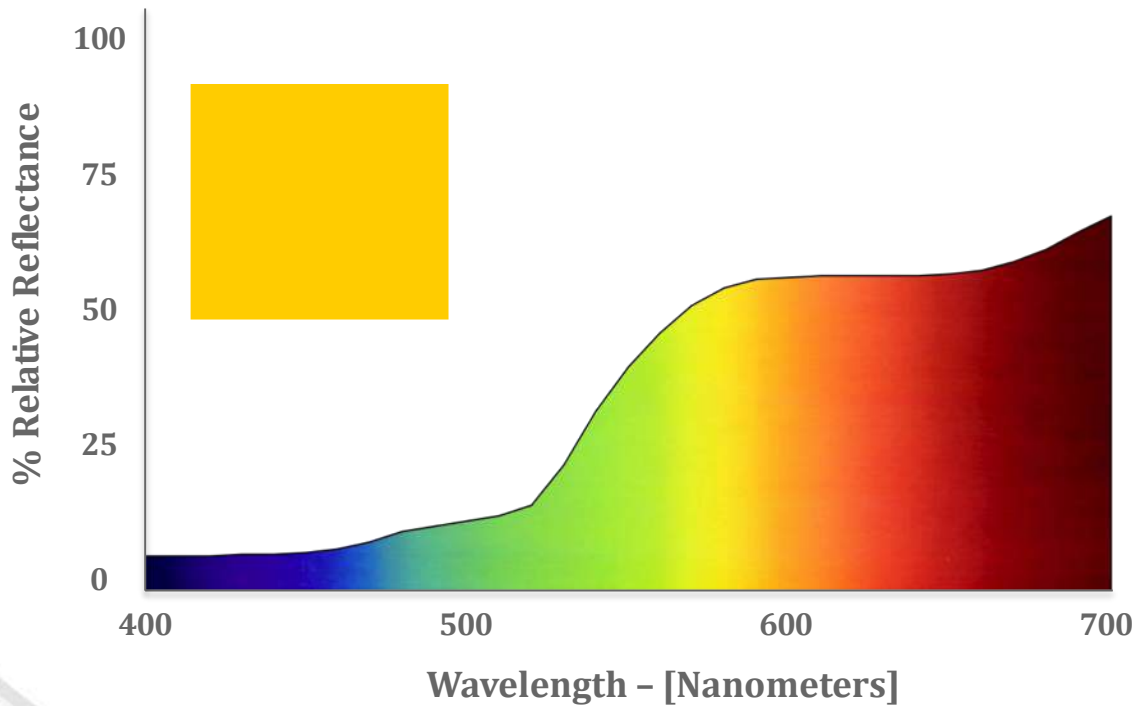

# Object



By measuring the relative reflectance or transmission characteristics of an object, the second element of the Visual Observing Situation has been quantified.



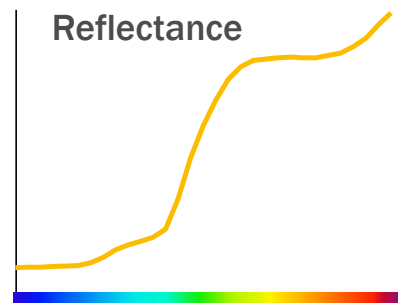
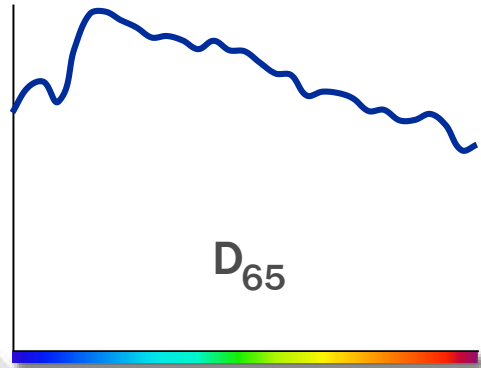
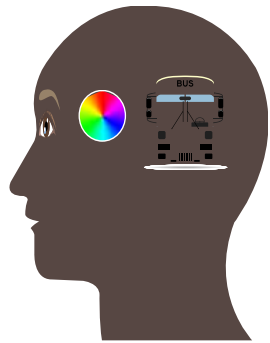
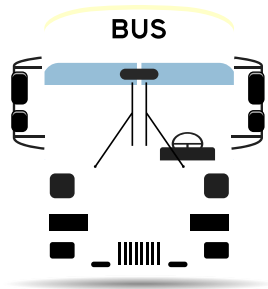



# Observer

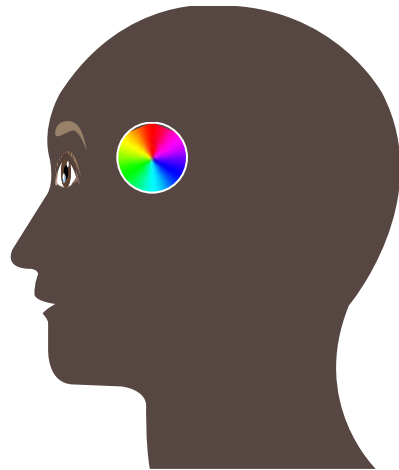

# Human Observer



**Rods** in the eye are responsible for low light vision.



**Cones** in the eye are responsible for color vision and function at higher light levels.



The three types of cone sensitivities are **red**, **green** and **blue**.

# The Human Eye

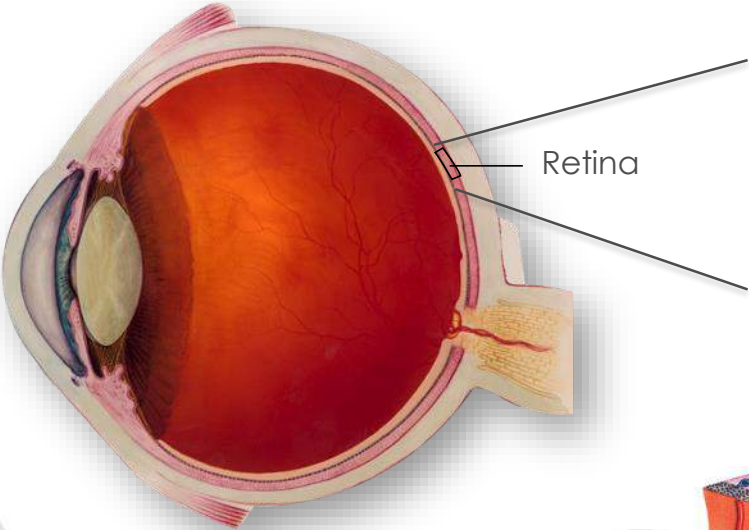

Light

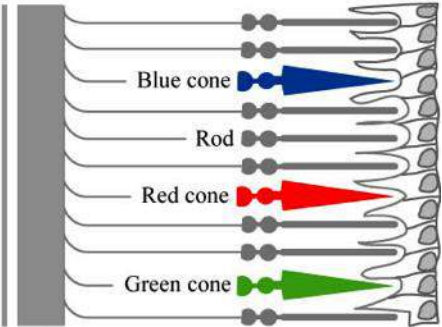

Light

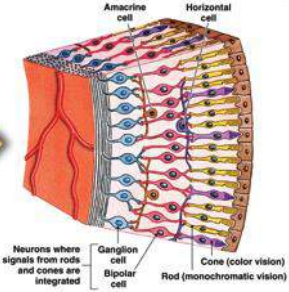

Retina

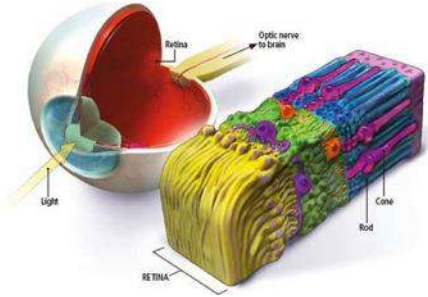

## CIE Standard Observer

Experiments were conducted to quantify the ability of the human eye to perceive color.

A human observer looked at a white screen through an aperture having a 2 degree field of view. Half of a screen was illuminated by a test light.

The observer adjusted the amount of three primary colored lights on the other half of the screen until they matched the test light color.

This process was repeated for colors across the visible spectrum.



# Determination of Standard Colorimetric Observer

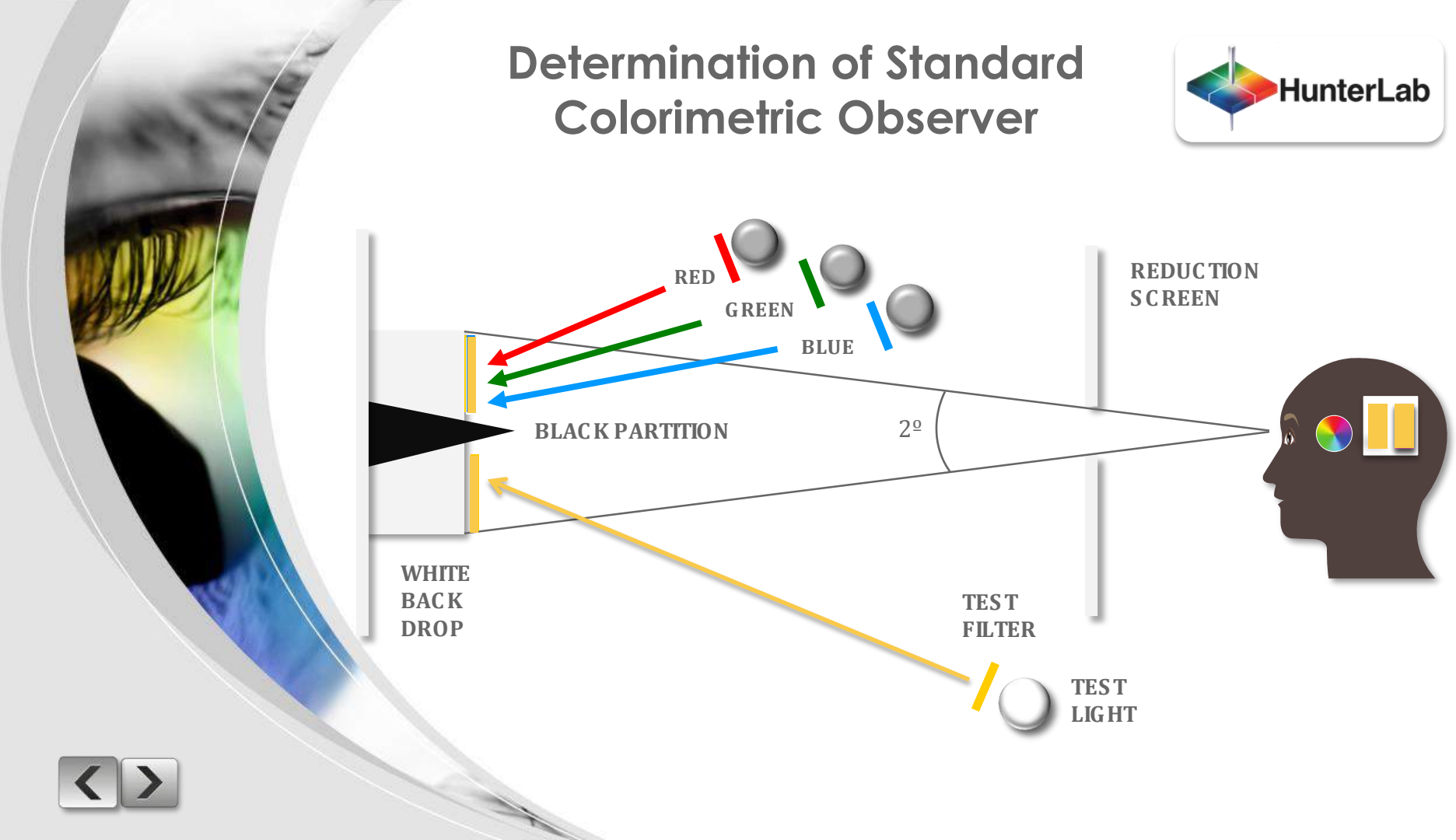

## CIE Standard Observer



The experimentally derived  $\bar{x}$ ,  $\bar{y}$ , and  $\bar{z}$  functions became the **CIE 1931 2° Standard Observer**.



These functions quantify the red, green and blue cone sensitivity of the average human observer.



# CIE 2° Standard Observer

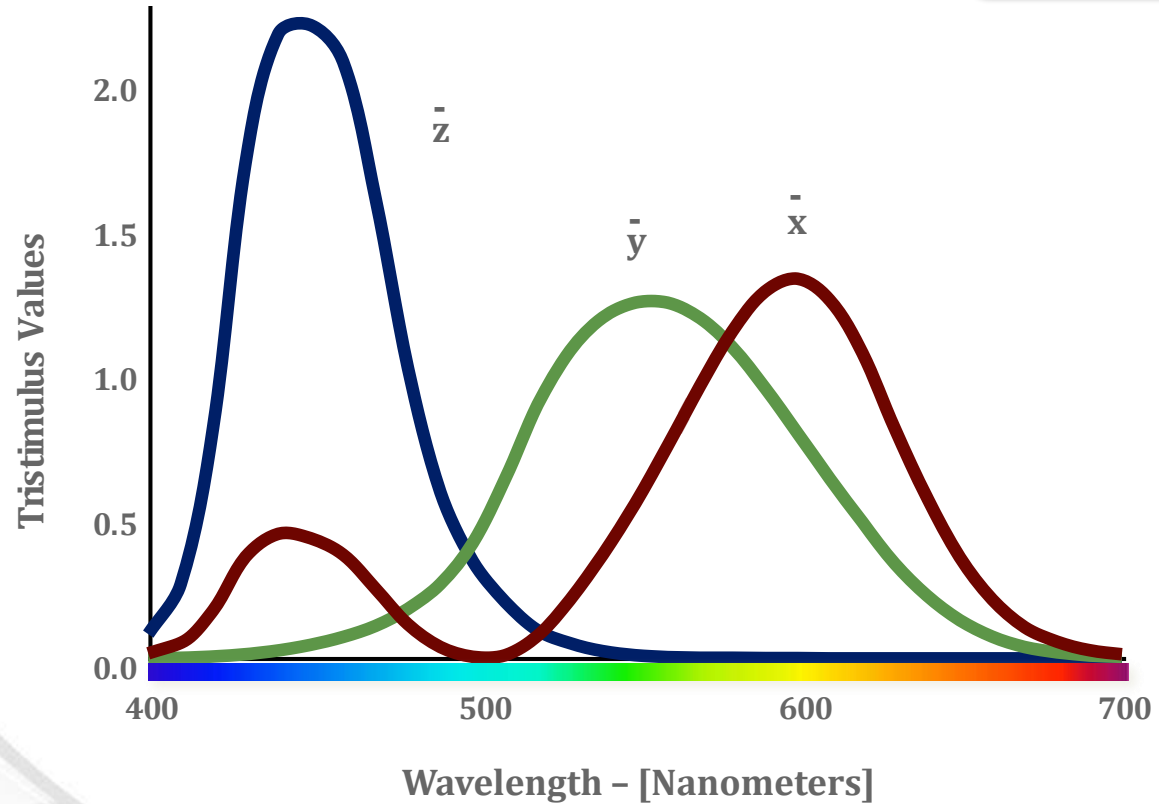

## Observer



When the 1931 2° Standard Observer experiments were conducted, it was thought that the cone concentration was only in the fovea region.



Later it was determined that the cones were spread beyond the fovea.



The experiments were re-done in 1964, resulting in the 1964 10° Standard Observer.

# 2° and 10° Observer

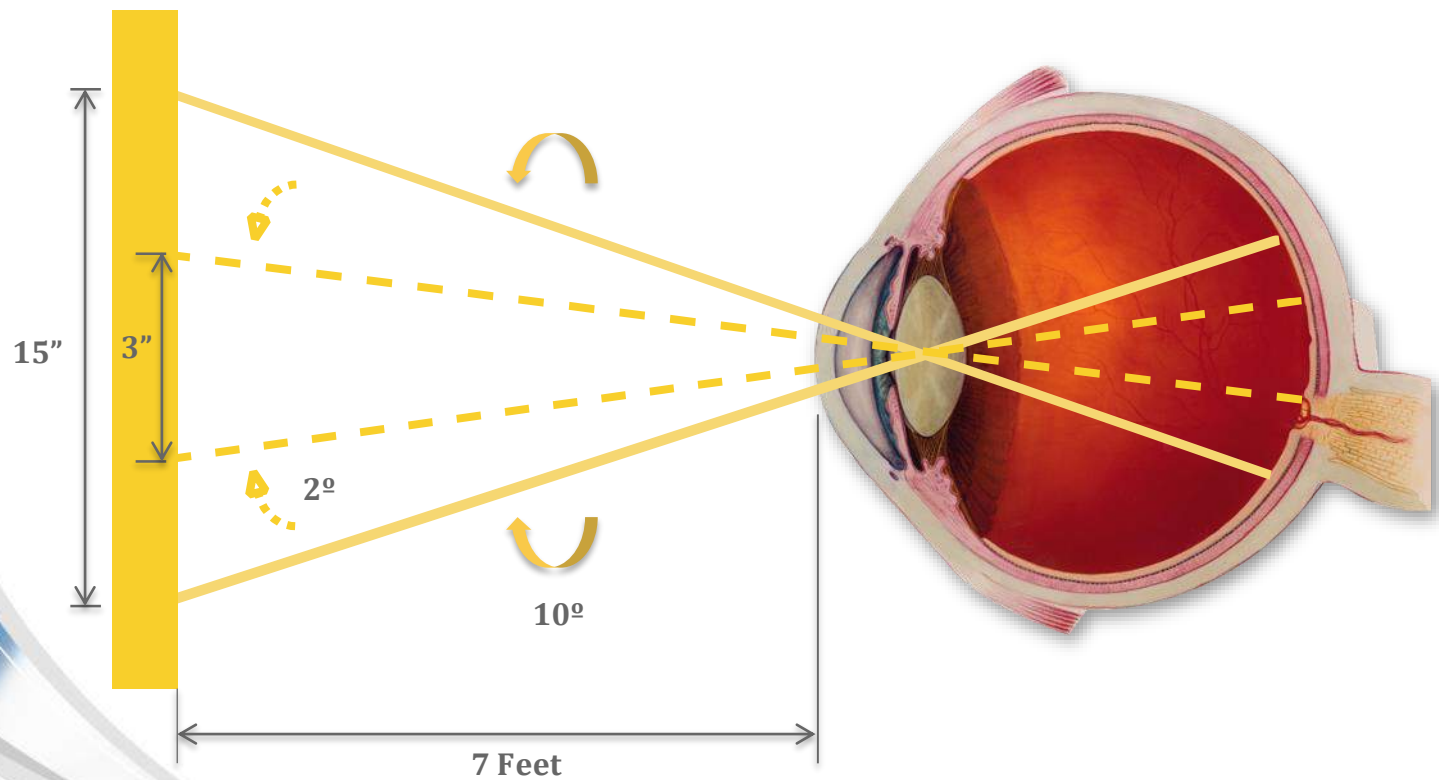

## 2° versus 10° CIE Standard Observer

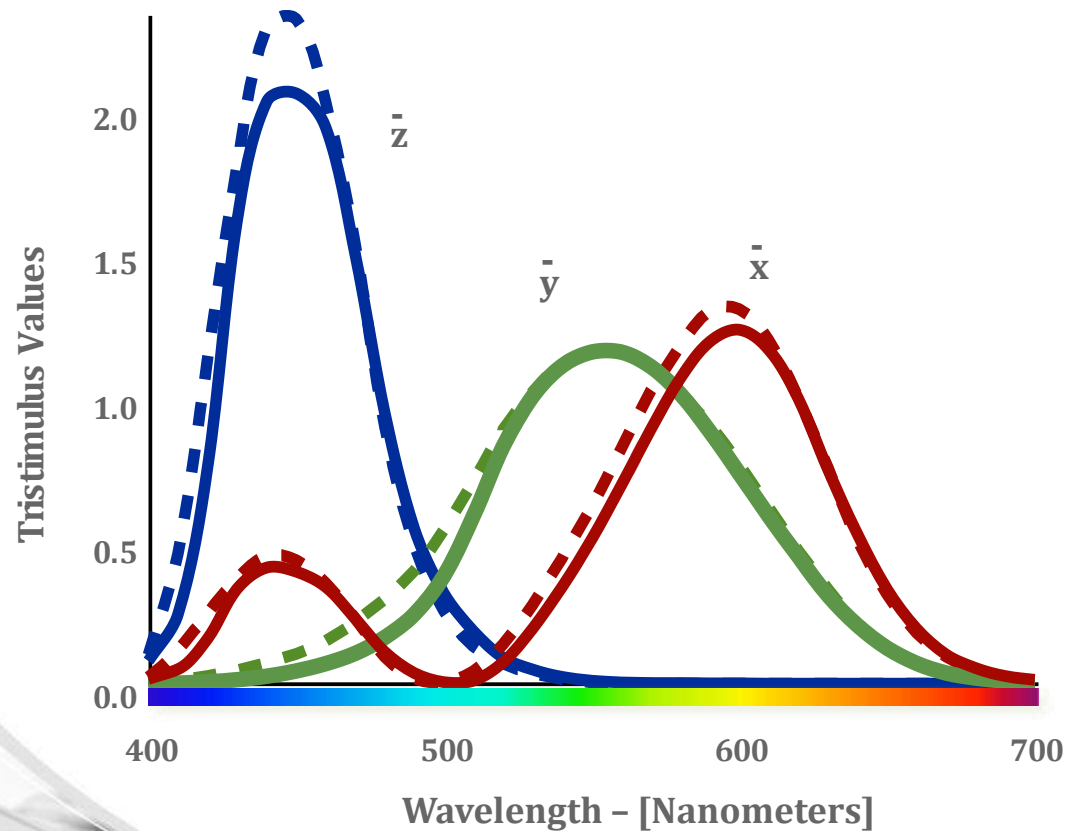

## CIE Recommended Observer



Of the two observers, the CIE recommends the 10° Standard Observer. It best correlates with average visual assessments made with large fields of view, typical of most commercial applications.



## Observer



The three elements of the Visual Observing Situation have now been quantified as tables of numbers.



The **Light Source** is a user-selected CIE illuminant.



The **Object** is quantified by measuring the reflectance or transmission.



The **Observer** is represented by a CIE Standard Observer.

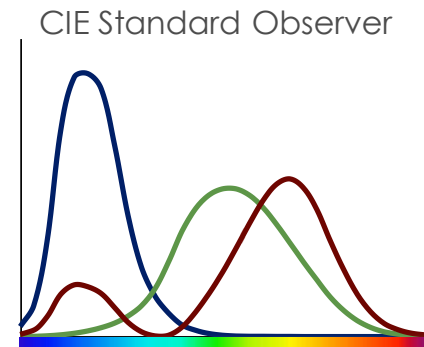
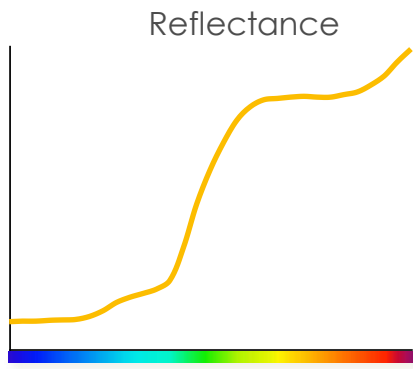
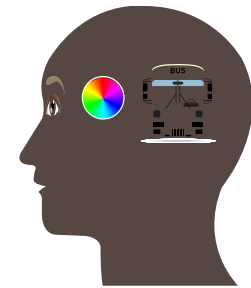
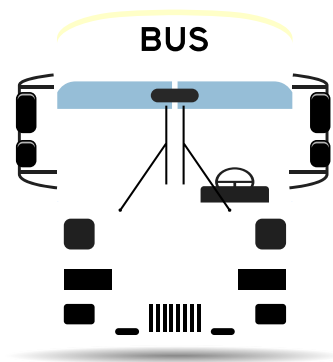
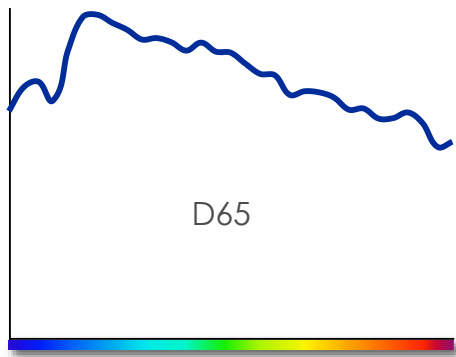
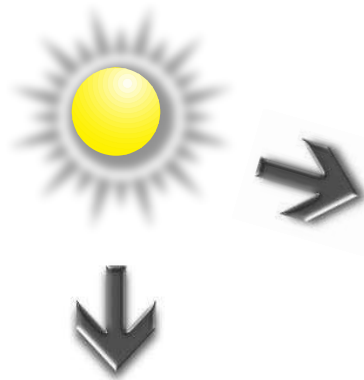
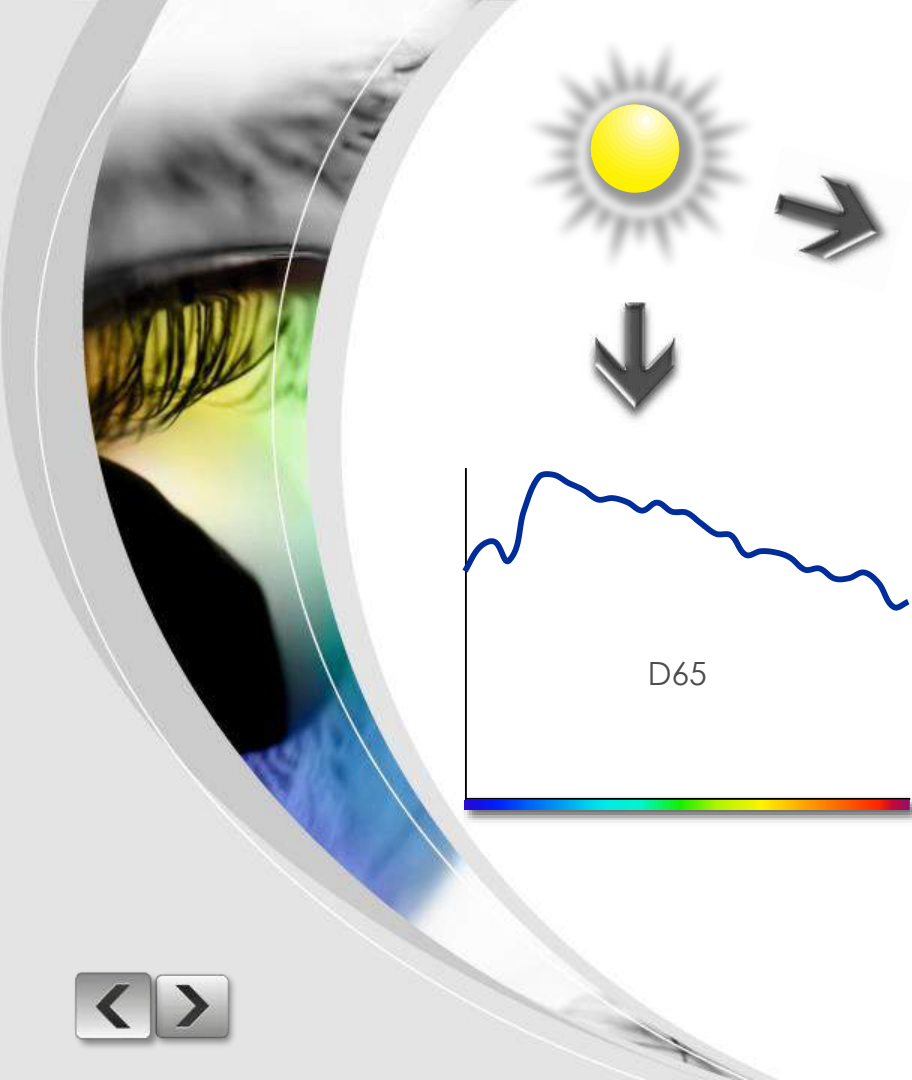







# COLOR MEASUREMENT



# Things Required



## To See Color

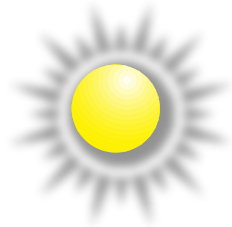

Light Source

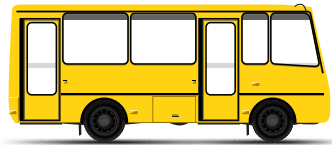

Object



Observer

## To Measure Color



Light Source



Sample





Spectrophotometer



# Color Measurement



-  The **CIE X, Y, Z tristimulus color values** are obtained by multiplying the illuminant, the reflectance or transmittance of the object, and the standard observer functions.
-  The product is then summed for all wavelengths in the visible spectrum to give the resulting **X, Y, Z tristimulus values**.



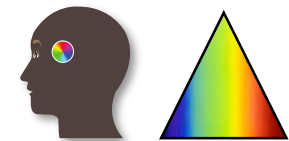
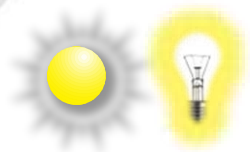

CIE Illuminant D65

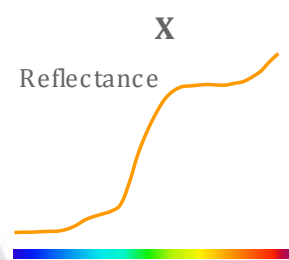
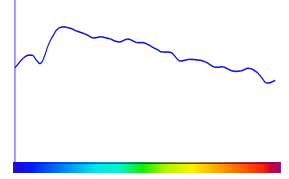

Visual Stimulus

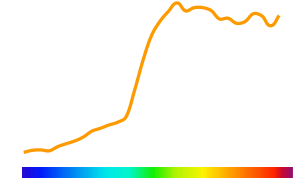

CIE  $\bar{x}$  Observer

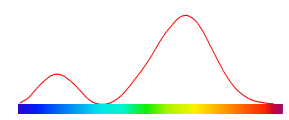

CIE  $\bar{y}$  Observer

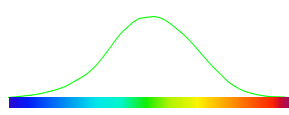

CIE  $\bar{z}$  Observer

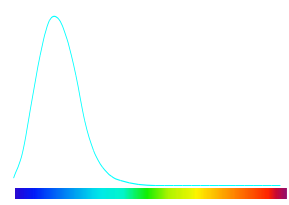

CIE X Tristimulus

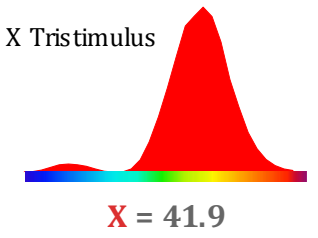

CIE Y Tristimulus

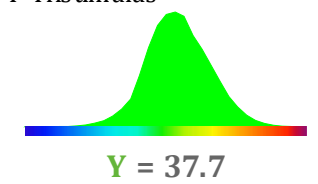

CIE Z Tristimulus

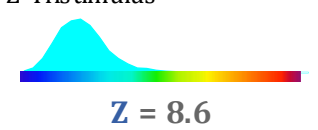

X = 41.9 Y = 37.7 Z = 8.6



# Measuring Color



A **Colorimetric Spectrophotometer** uses a light source to illuminate the sample being measured.

The light reflected by the object passes to a grating which breaks it into its spectral components.

This sample signal falls onto a diode array, measuring the amount of light at each wavelength.

The spectral data is sent to the processor where it is multiplied with user-selected illuminant and observer tables to obtain CIE X, Y, Z color values.



# Measuring Color

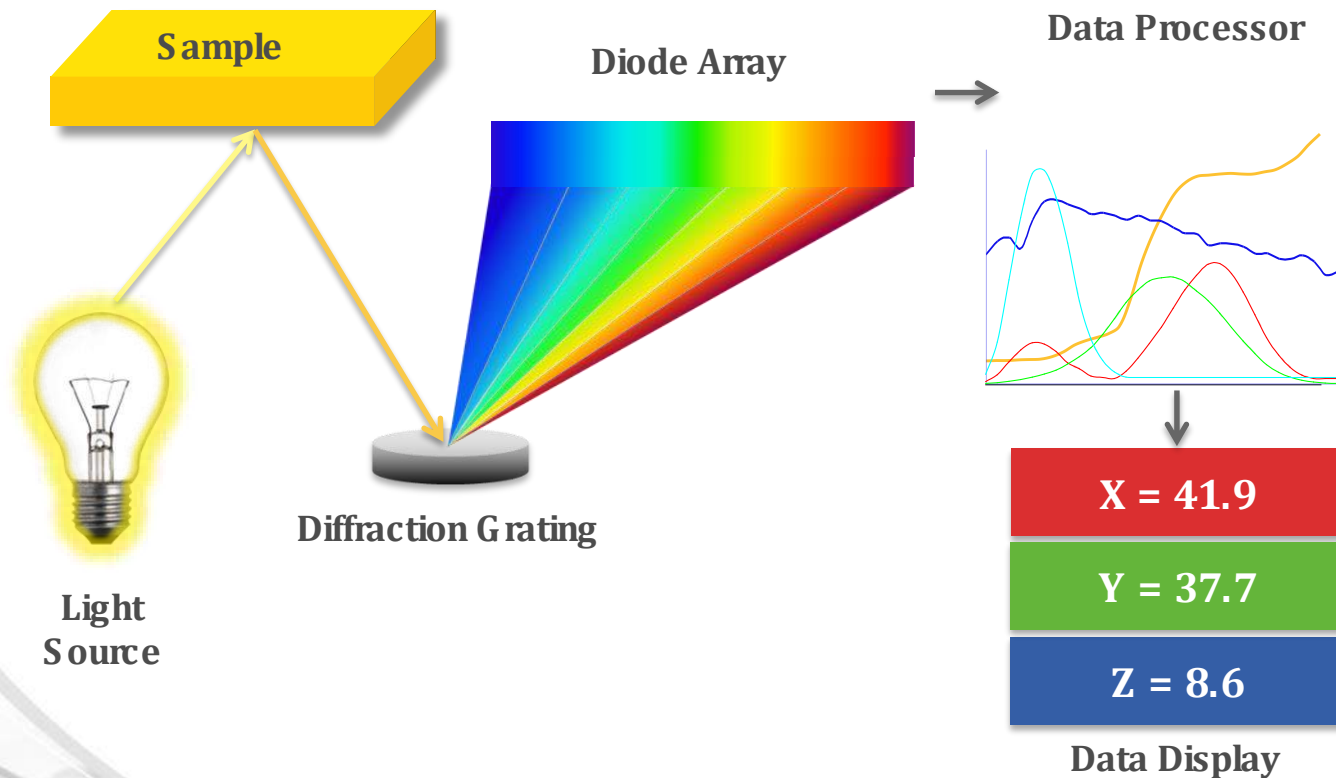



# HunterLab Spectrophotometer Systems



MiniScan® EZ



ColorFlex® EZ

LabScan® XE



UltraScan® VIS



ColorQuest® XT



UltraScan® PRO



ColorQuest® XE



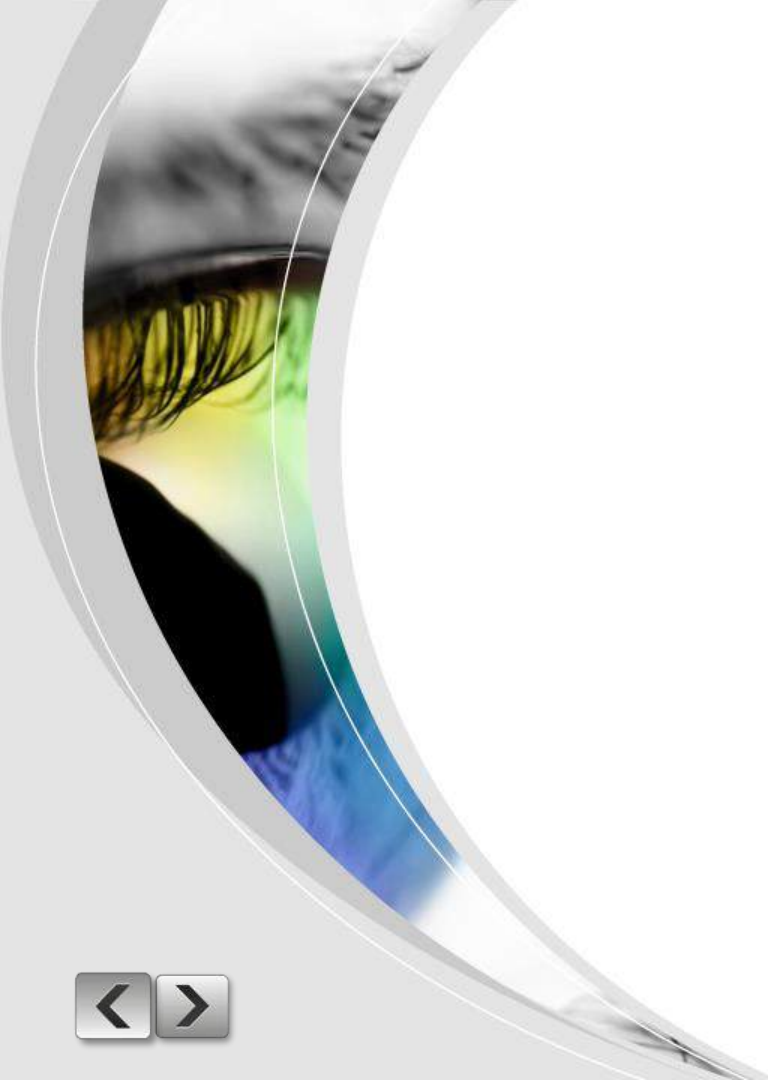



# COLOR SCALES



# Visual Organization of Color



All colors are organized in three dimensions: **Lightness**, **Chroma** or **Saturation** , and **Hue**.



# Visual Organization of Color

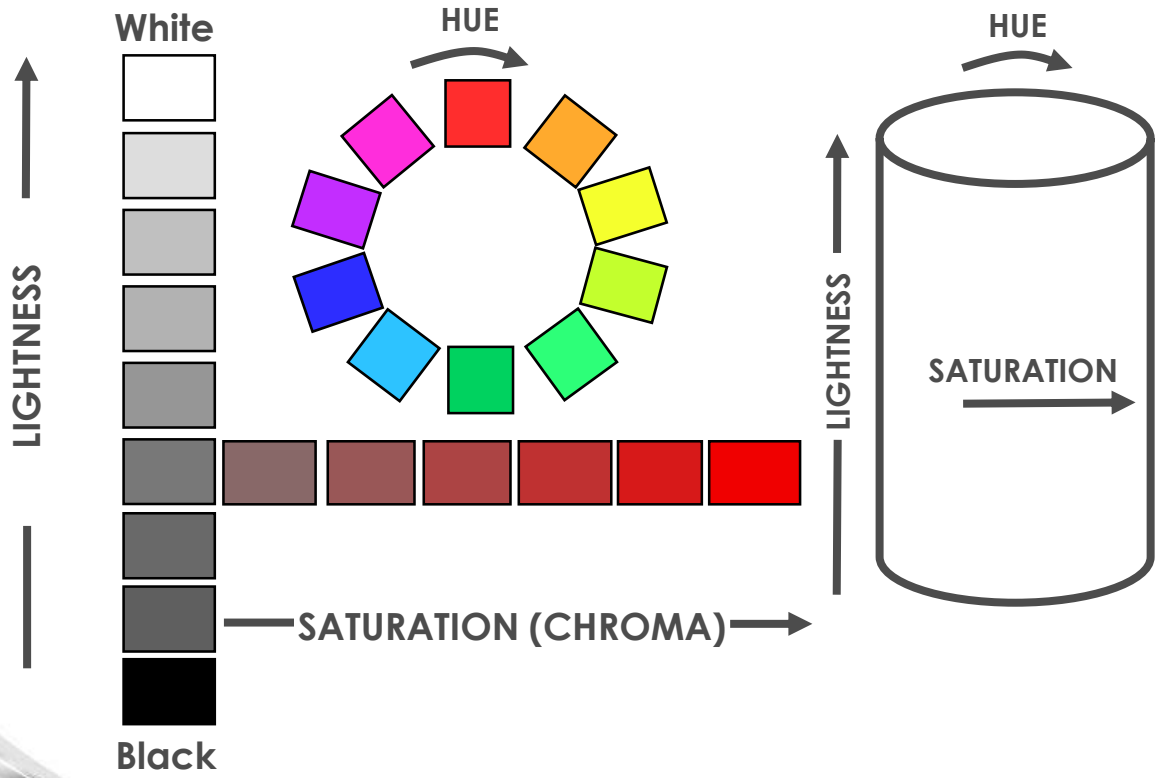

## Measured Color Values



Visual evaluation of color is **subjective** and **approximate**.



Measuring color using an instrument provides **objective** and **precise** results that correlate to human perception.

# “School Bus Yellow” Measured Values

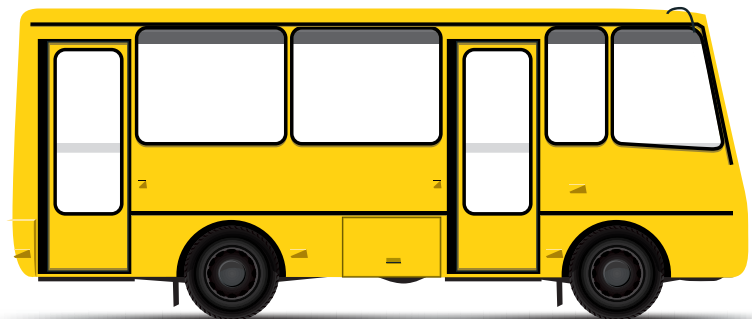

$$X = 41.9$$

$$Y = 37.7$$

$$Z = 8.6$$









# Color Scales



In terms of object color, X, Y, Z values are not easily understood. Other color scales have been developed to:

-  Better relate how we perceive color.
-  Simplify understanding.
-  Improve communication of color.
-  Better represent uniform color differences.



# Opponent-Colors Theory



States red, green and blue cone responses are remixed into opponent coders as they move up the optic nerve to the brain.



# Opponent-Colors Theory

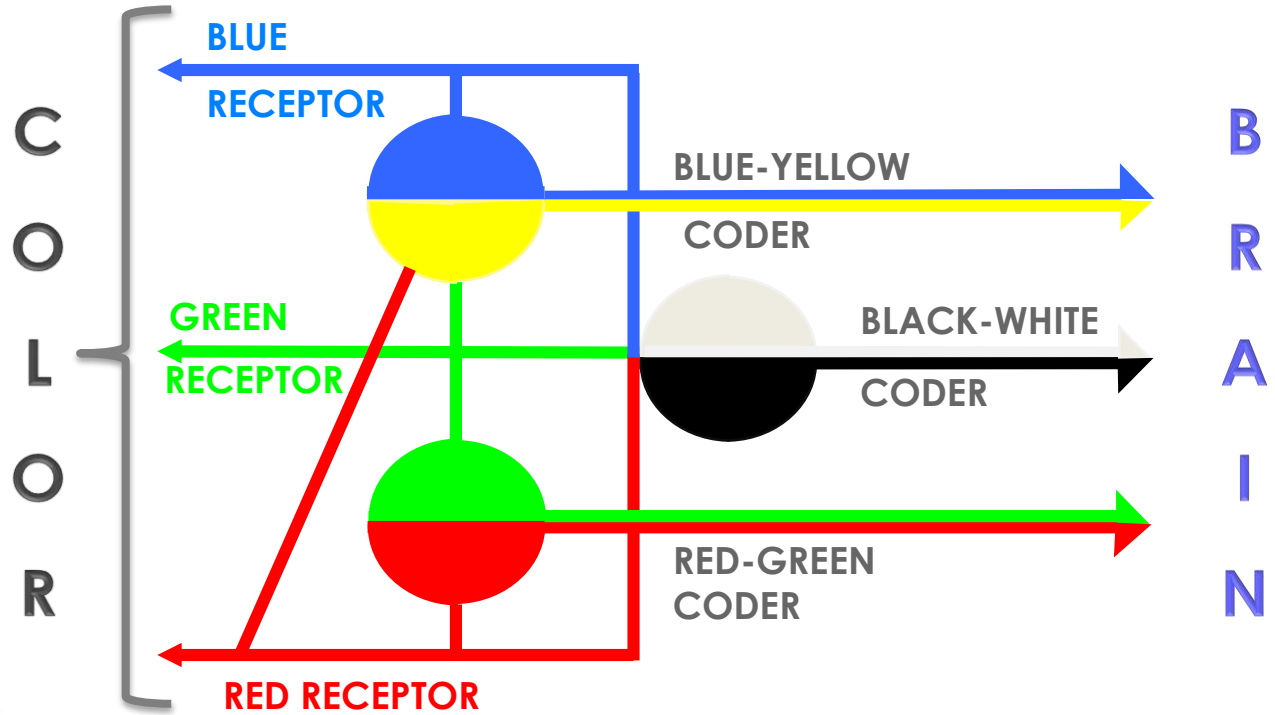

# Opponent-Colors Theory



When the next slide appears, focus on the black cross in the center of the stripes until the slide automatically changes to the white screen (after about 20 seconds).







# Opponent-Colors Theory



Did you see the stripes as red, white and blue?

This happens because the green, black and yellow stripes saturate the cone responses.

When you look at the blank screen your vision tries to return to balance and you see a red, white and blue after-image.

**This demonstration supports the Opponent-Colors Theory**





# Hunter L,a,b Color Space



Hunter L,a,b color space is a 3-dimensional **rectangular** color space based on Opponent-Colors Theory.



**L** (lightness) axis - 0 is black, 100 is white, and 50 is middle gray



**a** (red-green) axis - positive values are red, negative values are green, and 0 is neutral



**b** (blue-yellow) axis - positive values are yellow, negative values are blue, and 0 is neutral



# Hunter L,a,b Color Space

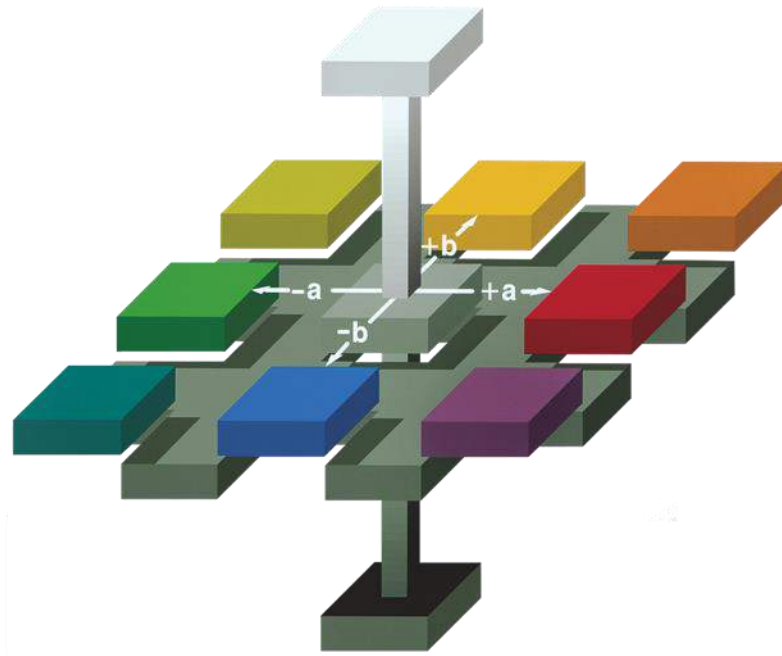

## Hunter L, a, b Color Space



All colors can be represented in L, a, b rectangular color space.



The following slide shows where “school bus yellow” falls in Hunter L, a, b color space.



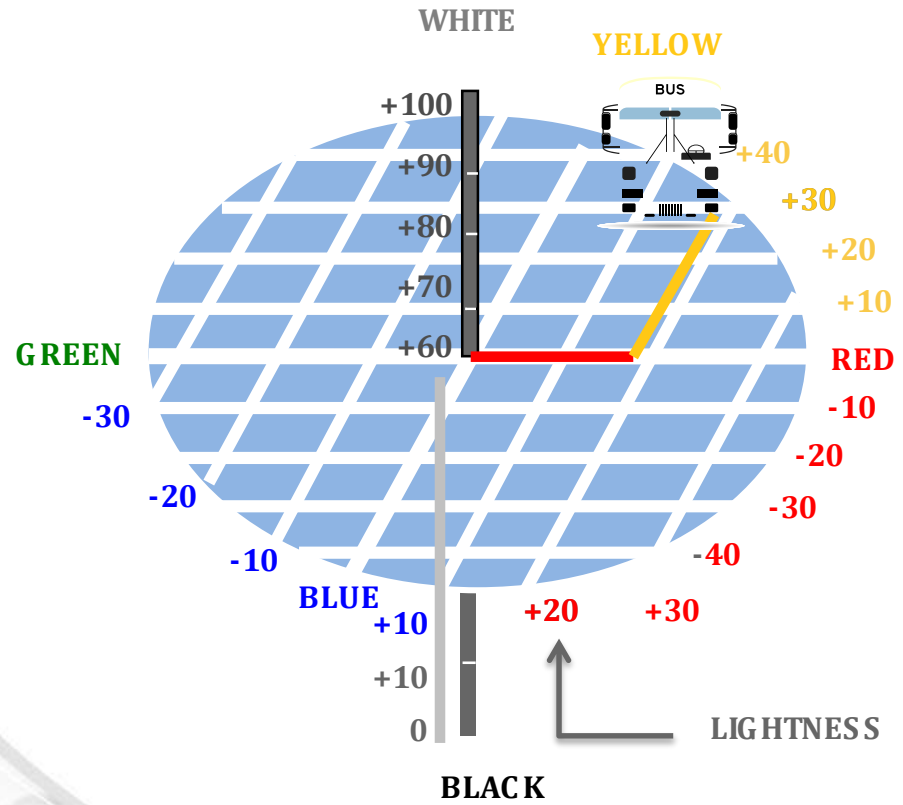
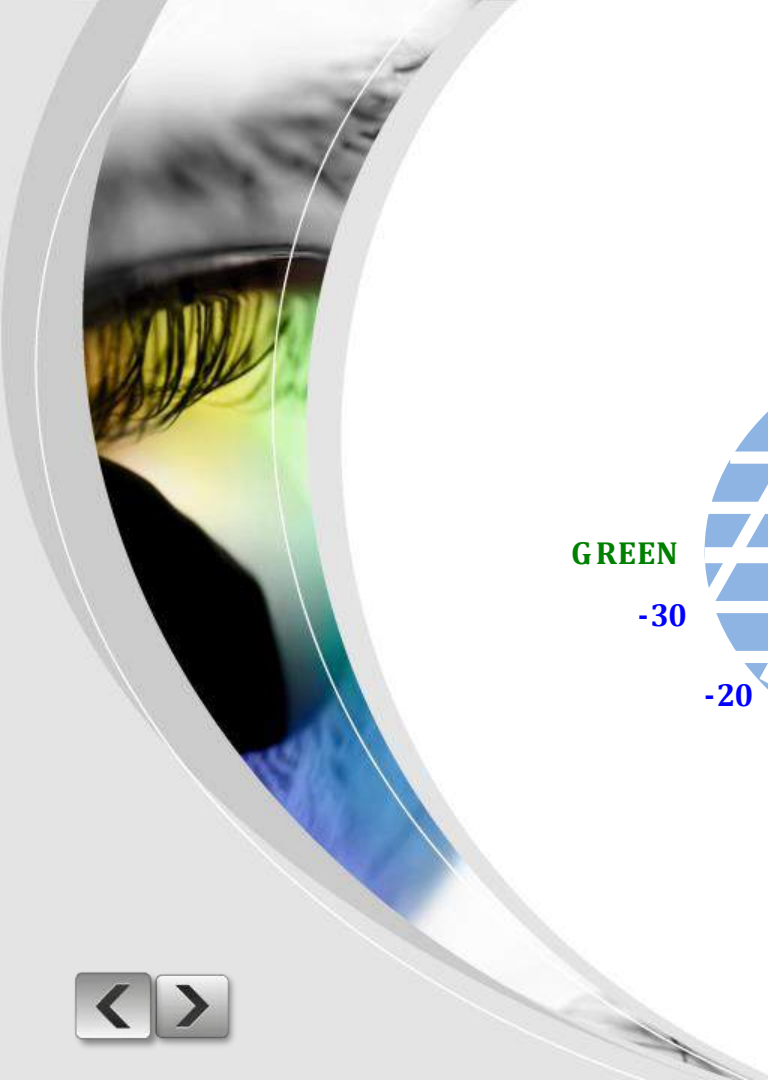

L= 61.4  
a= + 18.1  
b= +32.2

# Hunter L, a, b Values for “School Bus Yellow”

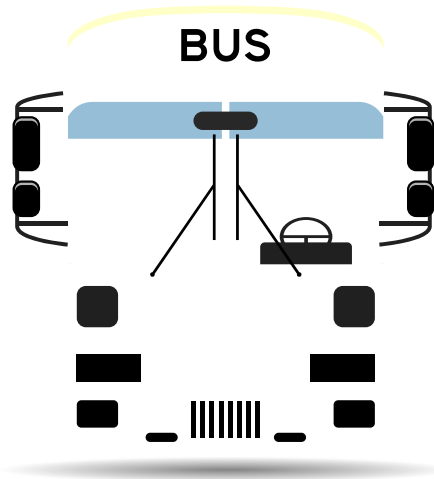

$$L = 61.4$$
$$a = + 18.1$$
$$b = + 32.2$$



## L, a, b Color Scales



There are two popular L,a,b color scales in use today: **Hunter L,a,b** and **CIE L\*,a\*,b\***.



While similar in organization, a color will have different numerical values in these two color spaces.

# Hunter L, a, b versus CIE L\*,a\*, b\*



## Hunter L, a, b (1958)

L = 61.42  
a = + 18.11  
b = + 32.23

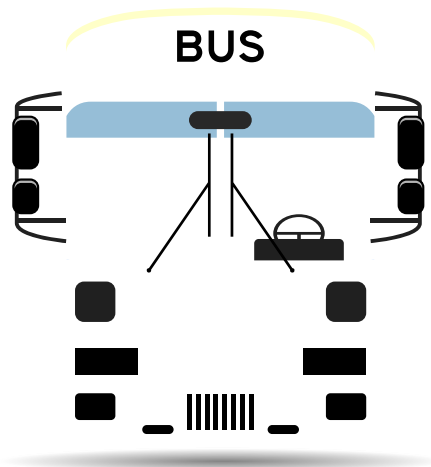

## CIE L\*,a\*,b\* (1976)



L\* = 67.81  
a\* = + 19.56  
b\* = + 58.16





# L, a, b Color Scales



-  Hunter L, a, b and CIE L\*,a\*,b\* scales are both mathematically derived from CIE X, Y, Z values.
-  Neither scale is visually uniform. Hunter L, a, b is over expanded in the blue region of color space and CIE L\*,a\*,b\* is over expanded in the yellow region.
-  **The current CIE recommendation is to use L\*,a\*,b\*.**



# Calculation of Color Formulas



## Hunter L, a, b

---

$$L = 100 (Y/Y_n)^{1/2}$$

$$a = \frac{K_a (X/X_n - Y/Y_n)}{(Y/Y_n)^{1/2}}$$

$$b = \frac{K_b (Y/Y_n - Z/Z_n)}{(Y/Y_n)^{1/2}}$$

## CIE L\*, a\*, b\*

---

$$L^* = 116 (Y/Y_n)^{1/3} - 16$$

$$a^* = 500 [(X/X_n)^{1/3} - (Y/Y_n)^{1/3}]$$

$$b^* = 200 [(Y/Y_n)^{1/3} - (Z/Z_n)^{1/3}]$$



# What is an Acceptable Color Difference?



Maximum Acceptable



Minimum Perceptible



## What is an Acceptable Color Difference?



What is an acceptable color difference varies with the application.

For example:



What is acceptable for color matching of automotive paint is close to being a **minimum perceptible** limit.



What is acceptable for snack foods is greater and the **maximum acceptable limit** defines the tolerance for the product.



## Rectangular $\Delta L^*$ , $\Delta a^*$ , $\Delta b^*$ Color Differences



Color Differences are always calculated as **SAMPLE - STANDARD** values.



If **delta L\*** is **positive**; the sample is **lighter** than the standard.

If **negative**; it would be **darker** than the standard.



If **delta a\*** is **positive**; the sample is **more red** (or **less green**) than the standard.

If **negative**; it would be **more green** (or **less red**).



If **delta b\*** is **positive**; the sample is **more yellow** (or **less blue**) than the standard.

If **negative**; it would be **more blue** (or **less yellow**).



# Rectangular $\Delta L^*$ , $\Delta a^*$ , $\Delta b^*$ Color Differences



SAMPLE

STANDARD



COLOR  
DIFFERENCES

$L^*$  = 71.9  
 $a^*$  = +10.2  
 $b^*$  = +58.1

$L^*$  = 69.7  
 $a^*$  = +12.7  
 $b^*$  = +60.5

$\Delta L^*$  = +2.2  
 $\Delta a^*$  = -2.5  
 $\Delta b^*$  = -2.4



## Delta E\* (Total Color Difference)



$\Delta E^*$  is based on  $L^*$ ,  $a^*$ ,  $b^*$  color differences and was intended to be a single number metric for **PASS/FAIL** decisions.



# Delta E\* (Total Color Difference)

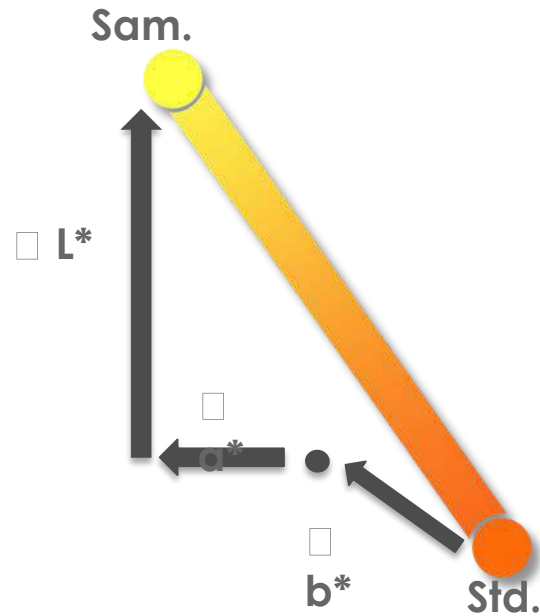
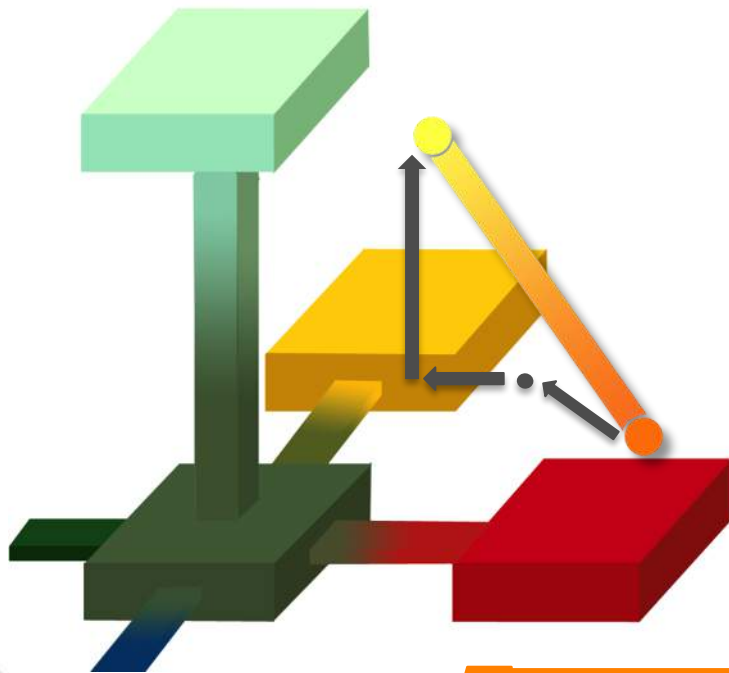

$$\Delta E^* = \sqrt{(\Delta L^*)^2 + (\Delta a^*)^2 + (\Delta b^*)^2}$$









# SURFACE CHARACTERISTICS & GEOMETRY



# Reflectance of Light



For opaque materials most of the incident light is reflected.

Color is seen in the diffuse reflection and gloss is seen in the specular reflection.

The reflection at the specular angle is generally the greatest amount of light reflected at any single angle.

However, specular reflection represents less than 4% of total reflected light.

The remaining reflection is diffuse reflection.

# Reflectance of Light



Incident Light

Diffuse  
Reflection

Specular  
Reflection

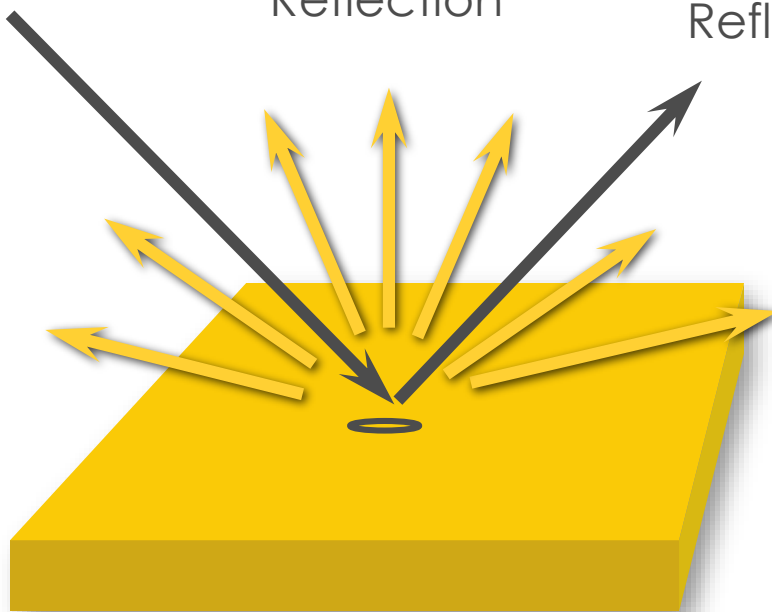

## Effect of Surface Texture on Perceived Color



Samples that are exactly the same color, but have different surface textures, will appear different.



Glossy surfaces appear darker and more saturated.



Matte and textured surfaces appear lighter and less saturated.



# Effect of Surface Texture on Perceived Color



**Rough**



**Glossy**

**Matte**



## Effect of Surface Texture on Perceived Color



Increased surface roughness affects perceived color such that it appears lighter and less saturated.

This is caused by mixing diffuse reflectance (where we see pigment color) with increased scatter from specular reflectance (white).

The rougher the surface, the greater the scatter of the specular reflectance.



# Light Distribution From Different Surfaces

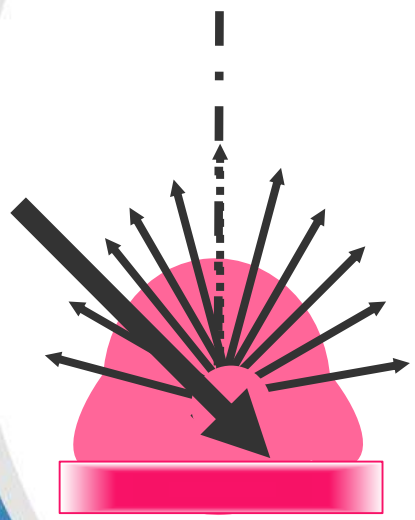

Matte

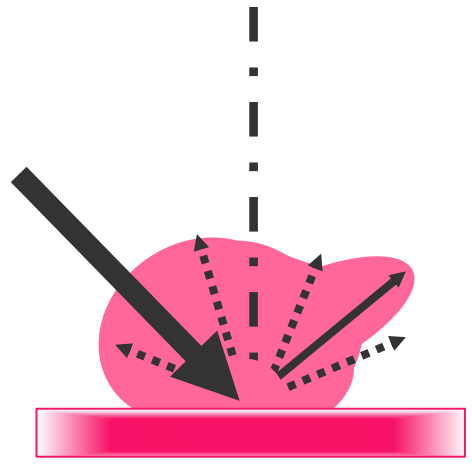

Semi-Gloss

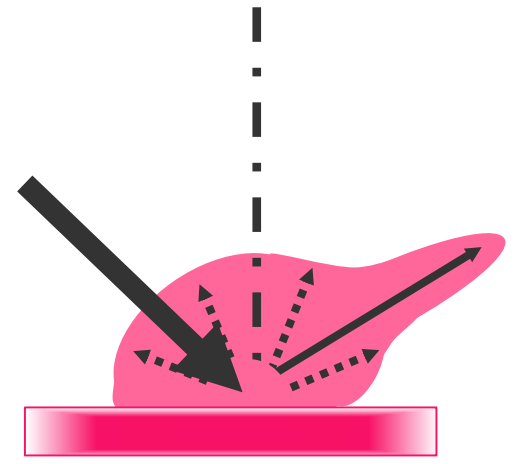

High Gloss





# Instrument Geometry



Instrument geometry defines the arrangement of light source, sample plane and detector.

There are two general categories of instrument geometries:

**Directional** ( $45^{\circ}/0^{\circ}$  or  $0^{\circ}/45^{\circ}$ ) and **diffuse** (d/ $8^{\circ}$  sphere).

## Directional Geometry



**Directional 45°/0°** geometry has illumination at a 45° angle and measurement at 0°.

The inverse **0°/45°** geometry has illumination at 0° and measurement at 45°.

Both exclude the specular reflection in the measurement (specular excluded).

This provides measurements that correspond to visual changes in sample appearance due to either changes in pigment color or surface texture.

# Directional 45°/0° and 0°/45° Geometry



### 45° Illumination/0° Measure

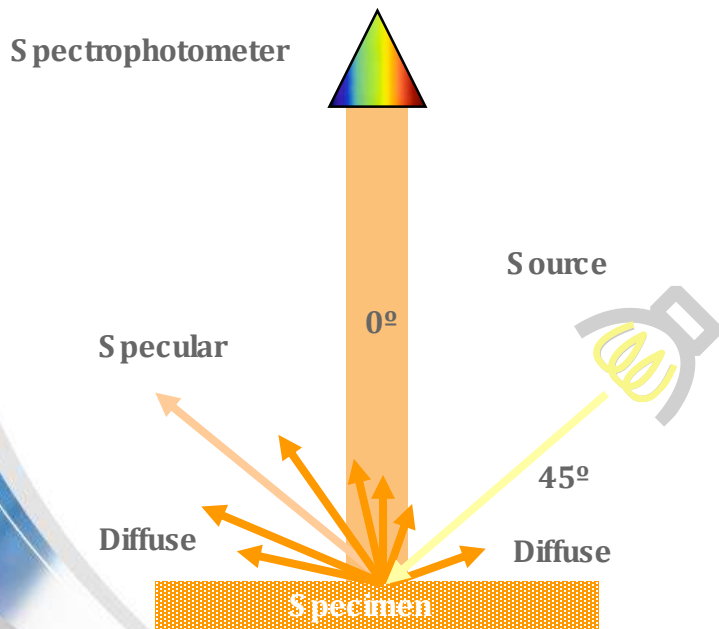

### 0° Illumination / 45° Measure

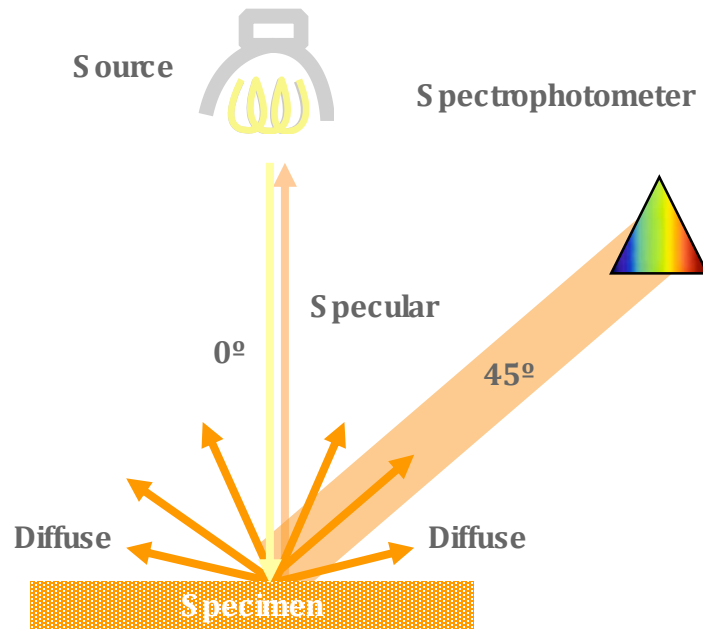

## Gloss Effect on Color Difference Measurement



On the following slide the paint on the card is the same color across the entire card. The right side has a matte surface finish and the left side has a high gloss finish.

The color difference measurement, made using a directional instrument, indicates a color difference that agrees with visual evaluation (the matte side is lighter and less red).

Directional instruments measure both the effect of the pigment and the effect of the surface finish. They are appropriate for quality control applications where agreement with what you see is important.



# Gloss Effect on Color Difference Measurement



Directional 0°/45° Geometry

	$\Delta L^*$	$\Delta a^*$	$\Delta b^*$
Specular Excluded	1.4	-1.5	-1.2



# A 0°/45° Geometry Spectrophotometer



LabScan<sup>®</sup> XE



## Diffuse Geometry



Diffuse (**sphere**) geometry instruments use a white coated sphere to diffusely illuminate the sample with  $8^\circ$  (**d/8°**) viewing.

Measurements on a diffuse sphere instrument can be taken with the **specular included** or **excluded**.



## Diffuse Geometry



**Specular Included** measurements negate surface differences and provide values which correspond to changes in color.

**Specular Excluded** measurements negate specular reflectance on very smooth surfaces, measuring only diffuse reflectance.

Most measurements are taken in the specular included mode.



# Sphere Geometry $d/8^\circ$



### Specular Included

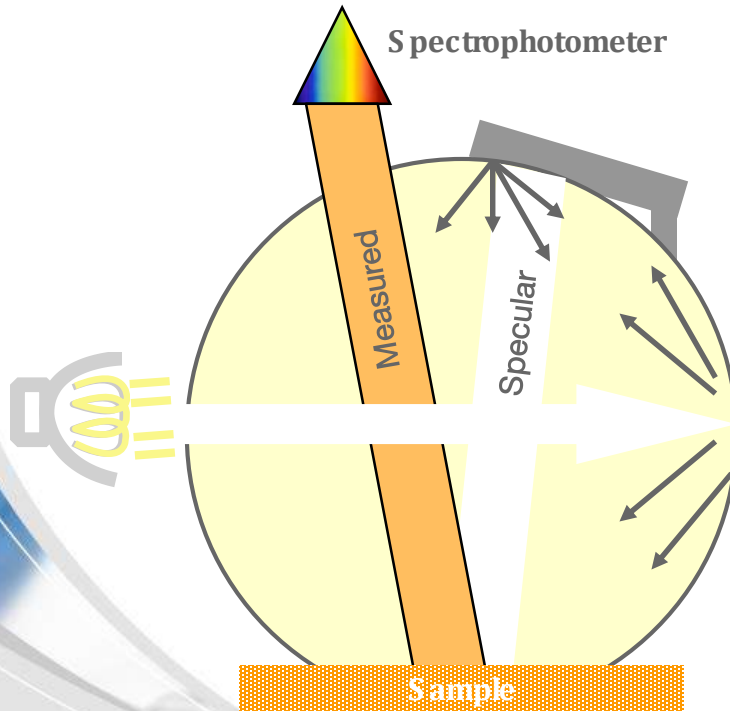

### Specular Excluded

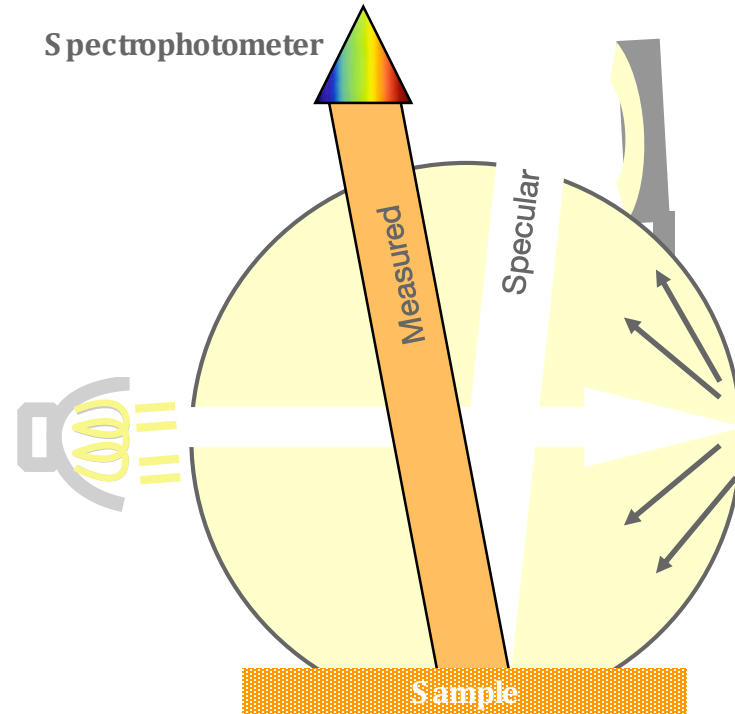

# Gloss Effect on Color Difference Measurement



On the next slide measurements were taken on the same card, using a diffuse  $d/8^\circ$  sphere instrument.

The specular included measurement indicates no color difference. It quantifies only colorant differences and negates differences in surface finishes.

In the specular excluded mode, the readings quantify appearance differences, similar to those from the  $0^\circ/45^\circ$  instrument.



# Gloss Effect on Color Difference Measurement



## Sphere Geometry

	$\Delta L^*$	$\Delta a^*$	$\Delta b^*$
Specular Included	0.0	0.1	-0.0
Specular Excluded	1.8	-1.6	-0.9



# Texture Effect on Color Difference Measurement



## Sphere Geometry

	$\Delta L^*$	$\Delta a^*$	$\Delta b^*$
Specular Included	0.1	-0.1	0.1
Specular Excluded	2.0	0.5	1.0

## 0°/45° Geometry





	$\Delta L^*$	$\Delta a^*$	$\Delta b^*$
Specular Excluded	5.2	1.8	2.5



# Sphere Geometry for Transmission



Sphere geometry instruments also have the ability to measure the color of transmitted light.

-  Color is seen primarily in **Regular Transmission** which transmits straight through transparent solids and liquids.
-  Surface texture or internal scattering within the material can cause the light to scatter or diffuse.
-  **Diffuse Transmission** also contains color of the material.
-  **Total Transmission** is a combination of regular plus diffuse transmission.



# Transmission of Light



Specular  
Reflection

Incident  
Light

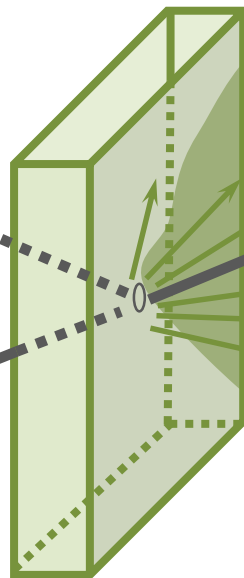

Regular  
Transmission

Diffuse  
Transmission

Total Transmission





# Sphere Instrument Measuring in Transmission



ColorQuest<sup>®</sup> XE

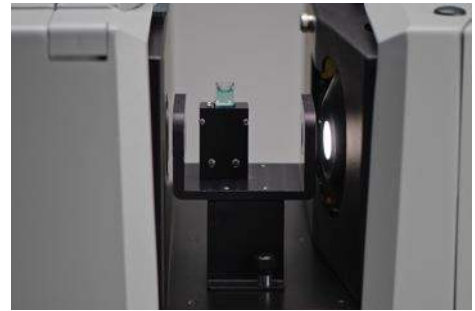
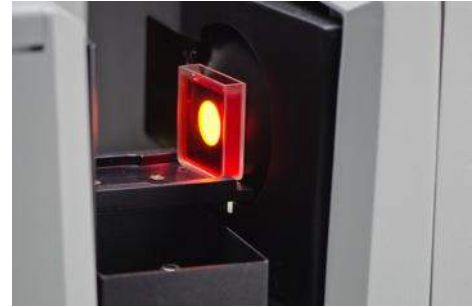







# SAMPLE PREPARATION & PRESENTATION



# Ideal Sample For Color Measurement



Opaque or transparent



Solid



Flat



Smooth



Uniform



## Sample Preparation and Presentation



- ☑ Choose samples that are representative of the product.
- ☑ Prepare the sample in a way to best approximate the ideal sample characteristics.
- ☑ Prepare samples in the same way each time.
- ☑ Present the samples to the instrument in a repeatable manner.
- ☑ Take multiple readings of the sample for an average measurement.



# Examples of Sample Preparation and Presentation

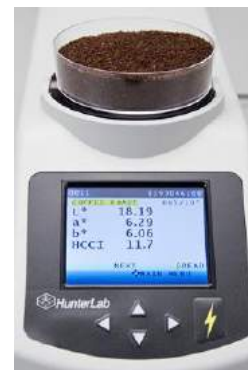
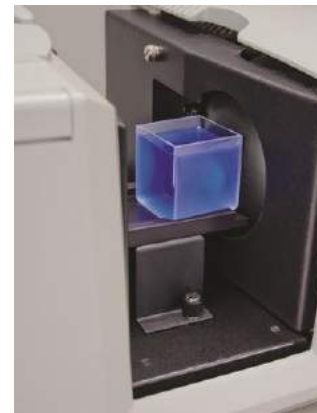
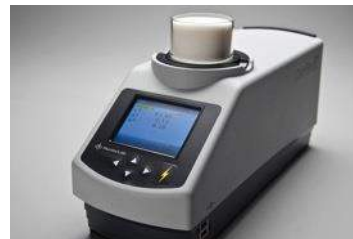

# Thank You



If you are connected to the internet click:



For more information about sample preparation and presentation



For product information

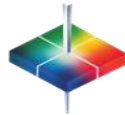

visit our website at [www.hunterlab.com](http://www.hunterlab.com)

or

contact us at [info@hunterlab.com](mailto:info@hunterlab.com)







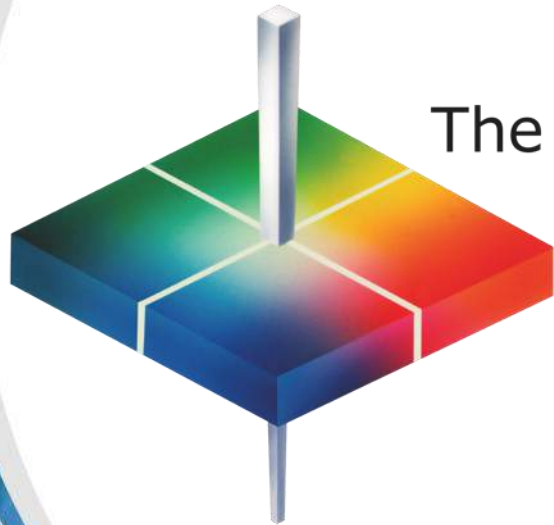
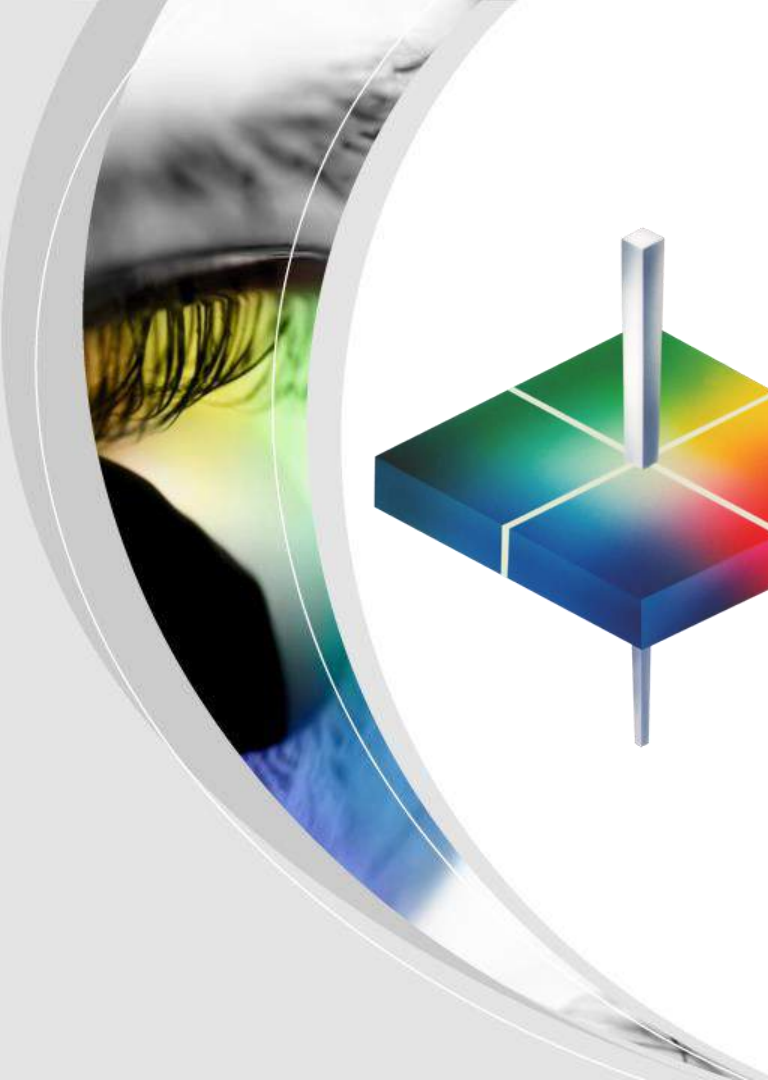

The world's true measure of color

# HunterLab